

Technical specification

- 1 Worktop** - MFC 28 mm, ABS edge
- 2 Top** - tempered optiwhite glass, 8 mm - painted on bottom side
- 3 Front** - glass LACOBEL 4 mm
- 4 LED illumination** - at the full length of the reception desk, cold white color (verging on the blue shade);
- 5 Corner slate** - stainless steel 4 mm
- 6 Kick plate** - HPL - brushed aluminium
- 7 Leveling** - 5 mm range

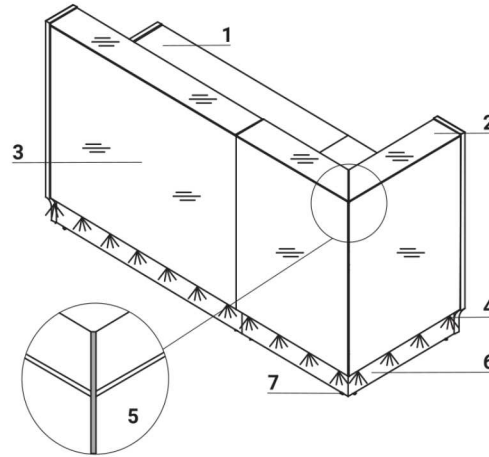

Technical specification

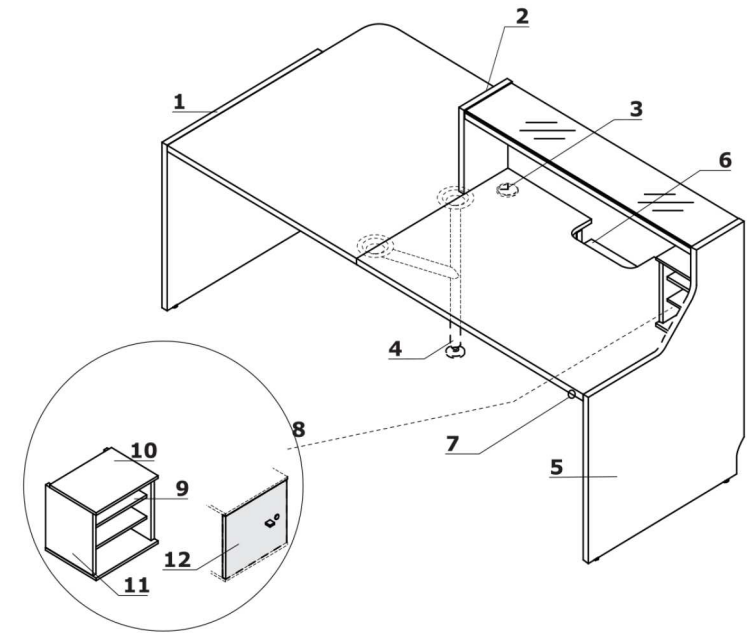

- 1 Low side panel** - MFC 28 mm, ABS edge
- 2 Side panel linking low and high fronts** - MFC 28 mm, ABS edge
- 3 Cable grommets** - Ø80 mm
- 4 Supporting leg NL41** - required for connecting the tops
- 5 High side panel** - MFC 28 mm, ABS edge
- 6 OPTION WITH EXTRA CHARGE** - working top with lowered monitor shelf - MFC 28 mm, ABS edge
- 7 Light switch**
- 8 LMS05** - reception desk storage; order separately
- 9 Shelf** - MFC 12 mm, ABS edge
- 10 Top** - MFC 12 mm, ABS edge
- 11 Body** - MFC 18 mm, ABS edge
- 12 Optional front with lock** - universal (left, right); - MFC 18 mm, ABS edge; - ordered as separate element

Ending elements application

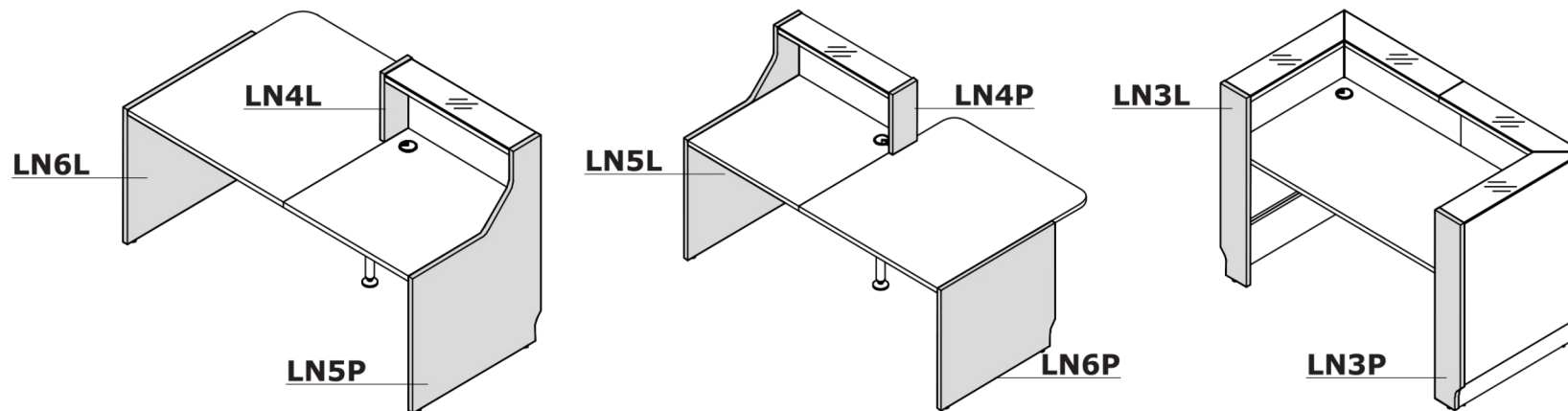

Dimensions

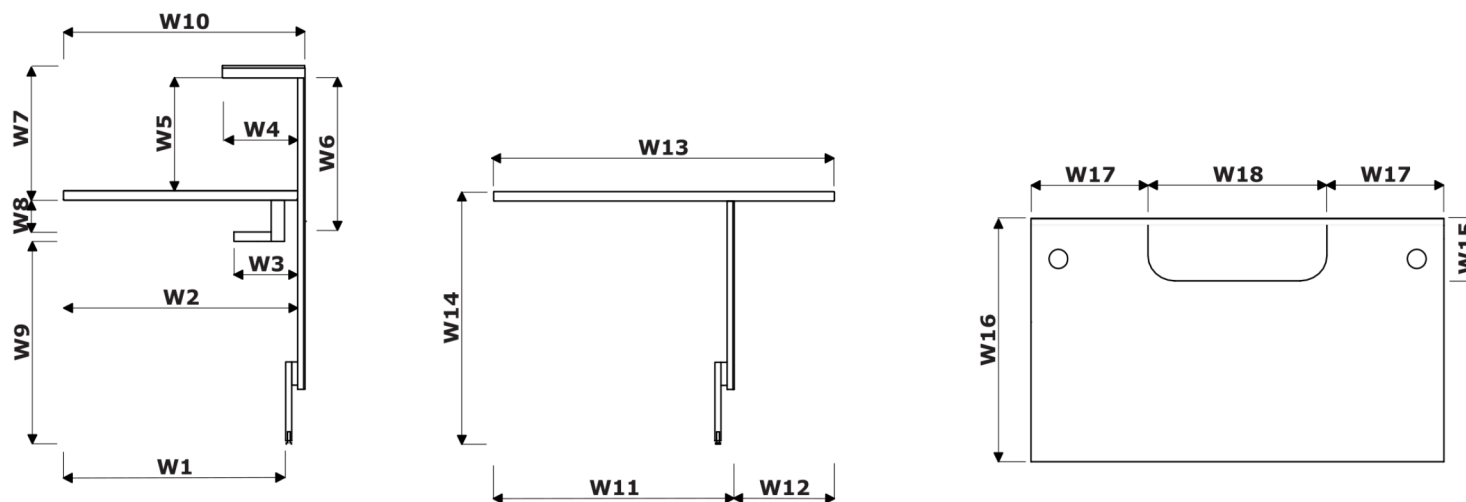

W1 - 763 mm | W2 - 800 mm | W3 - 200 mm | W4 - 228 mm | W5 - 329 mm | W6 - 452 mm | W7 - 365 mm | W8 - 95 mm | W9 - 589 mm | W10 - 822 mm | W11 - 822 mm | W12 - 300 mm | W13 - 1122 mm | W14 - 740 mm | W15 - 200 mm | W16 - 800 mm | W17 340/540 mm | W18 - 520 mm |

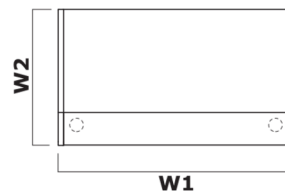
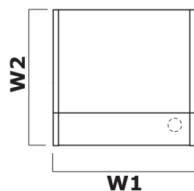
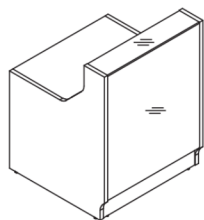

Symbol		Dimensions					kg m3 pcs	Composition elements
		W1	W2	D1	D2	H		
LIN08		856	824	2280	600	1105	69.5 kg 0.345 m3 5 pcs	
LIN13		1256	824	2280	600	1105	87.5 kg 0.479 m3 5 pcs	

Extra charge						

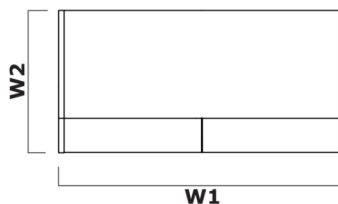
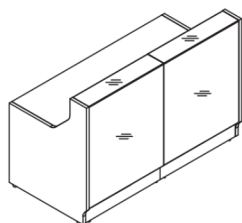

Symbol		Dimensions					kg m3 pcs	Composition elements
		W1	W2	D1	D2	H		
LIN15		1656	824	2280	600	1105	107 kg 0.623 m3 7 pcs	

Extra charge						
Monitor shelf x1						
X						

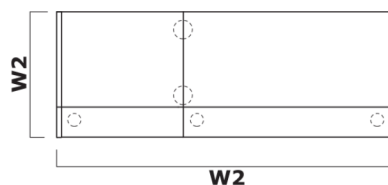
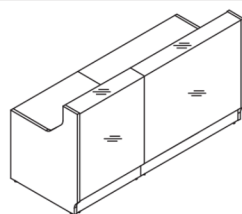

Symbol		Dimensions					kg m3 pcs	Composition elements
		W1	W2	D1	D2	H		
LIN20		2056	824	2280	600	1105	134 kg 0.826 m3 10 pcs	

Extra charge						
Monitor shelf x1						
X						

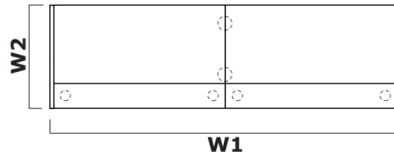
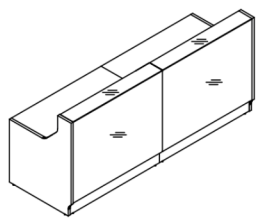

Symbol		Dimensions					kg m3 pcs	Composition elements
A	B	W1	W2	D1	D2	H		
LIN25		2456	824	2280	600	1105	149 kg 0.955 m3 9 pcs	

Extra charge					
Monitor shelf x1	Monitor shelf x2				
X	X				

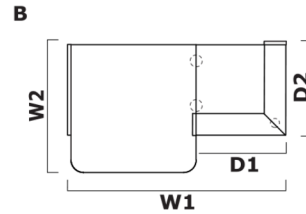
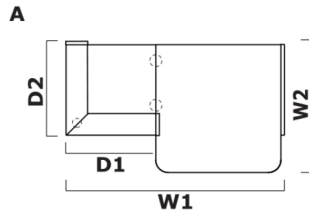
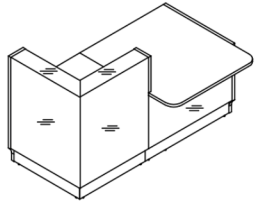

Symbol		Dimensions					kg m3 pcs	Composition elements
A	B	W1	W2	D1	D2	H		
LIN29L	LIN29P	1850	1150	822	850	1105	147.5 kg 1.296 m3 9 pcs	A - B -
LIN291L	LIN291P	1650	1150	822	850	1105	142.5 kg 1.269 m3 9 pcs	A - B -

Extra charge					

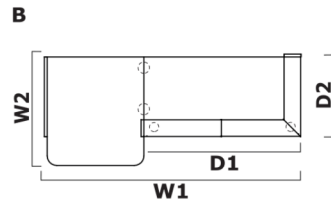
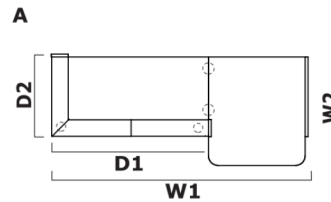
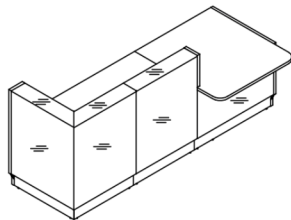

Symbol		Dimensions					kg m3 pcs	Composition elements
A	B	W1	W2	D1	D2	H		
LIN35L	LIN35P	2650	1150	1622	850	1105	188 kg 1.58 m3 12 pcs	A - B -
LIN351L	LIN351P	2450	1150	1622	850	1105	183 kg 1.553 m3 12 pcs	A - B -

Extra charge					
Monitor shelf x1					
X					
X					

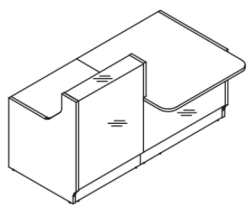

A

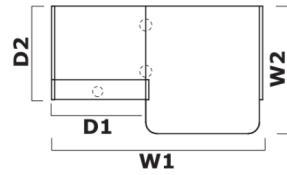

B

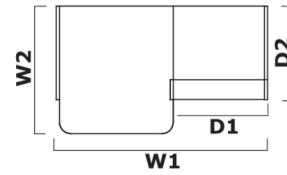

Symbol			Dimensions					kg m3 pcs	Composition elements
A	B		W1	W2	D1	D2	H		
LIN33L	LIN33P		1856	1122	828	824	1105	103.5 kg 0.562 m3 9 pcs	A - B -
LIN331L	LIN331P		1656	1122	828	824	1105	98.5 kg 0.536 m3 9 pcs	A - B -

Extra charge

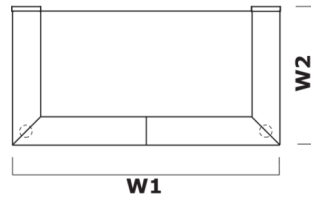
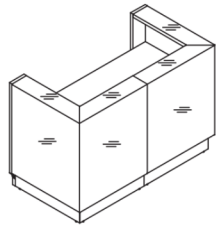

Symbol			Dimensions					kg m3 pcs	Composition elements
			W1	W2	D1	D2	H		
LIN36			1644	850	828	824	1105	198 kg 2.096 m3 8 pcs	

Extra charge

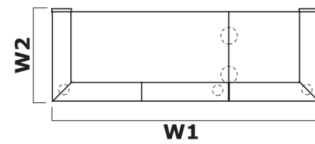
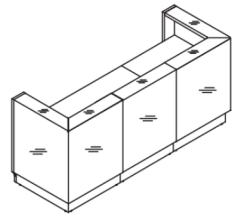

Symbol			Dimensions					kg m3 pcs	Composition elements
			W1	W2	D1	D2	H		
LIN42			2444	850	828	824	1105	241.5 kg 2.439 m3 12 pcs	

Extra charge

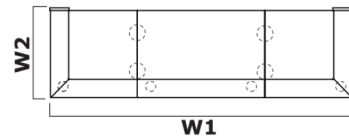
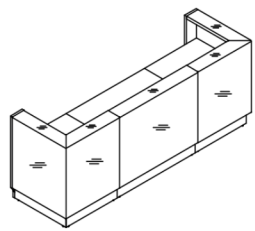

Symbol		Dimensions					kg m3 pcs	Composition elements
		W1	W2	D1	D2	H		
LIN43		2844	850	828	824	1105	265.5 kg 2.637 m3 14 pcs	

Extra charge					

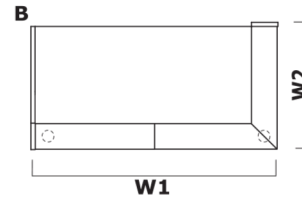
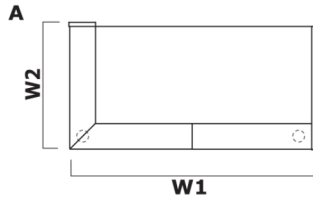
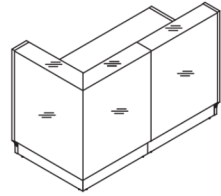

Symbol		Dimensions					kg m3 pcs	Composition elements
A	B	W1	W2	D1	D2	H		
LIN37L	LIN37P	1650	850	828	824	1105	154 kg 1.362 m3 8 pcs	A - B -

Extra charge					

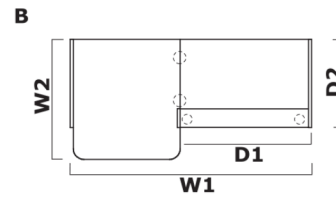
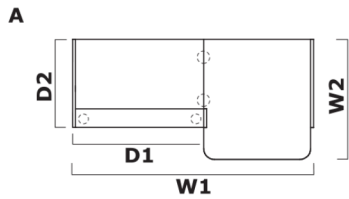
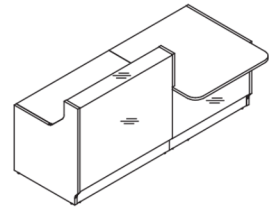

Symbol		Dimensions					kg m3 pcs	Composition elements
A	B	W1	W2	D1	D2	H		
LIN34L	LIN34P	2256	1122	1228	824	1105	124.5 kg 0.701 m3 10 pcs	A - B -
LIN341L	LIN341P	2056	1122	1228	824	1105	119.5 kg 0.674 m3 10 pcs	A - B -

Extra charge					

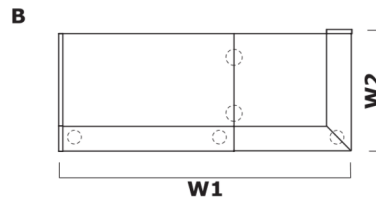
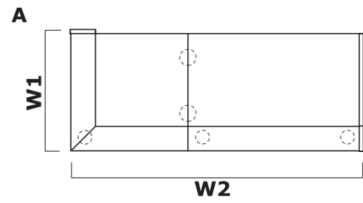
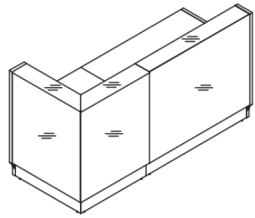

Symbol			Dimensions					kg m3 pcs	Composition elements
A	B		W1	W2	D1	D2	H		
LIN38L	LIN38P		2050	850	1228	824	1105	178 kg 1.56 m3 10 pcs	A - B -

Extra charge					

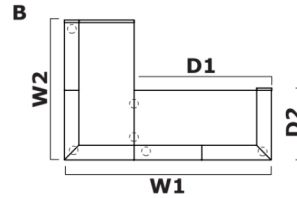
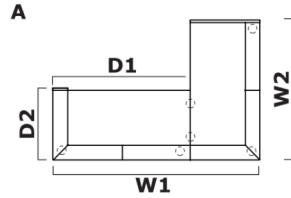
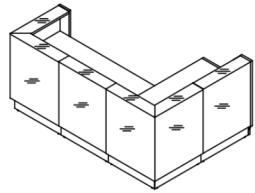

Symbol			Dimensions					kg m3 pcs	Composition elements
A	B		W1	W2	D1	D2	H		
LIN39L	LIN39P		2444	1650	1622	850	1105	286 kg 2.735 m3 14 pcs	A - B -

Extra charge					

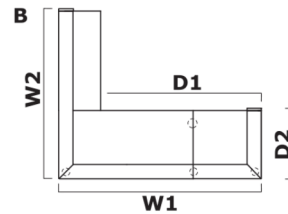
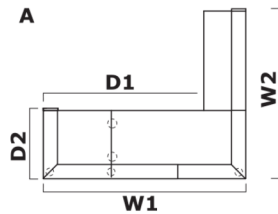
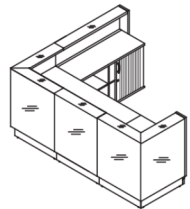

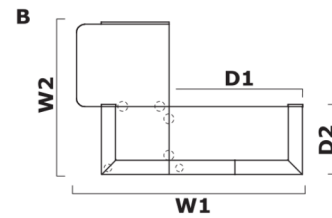
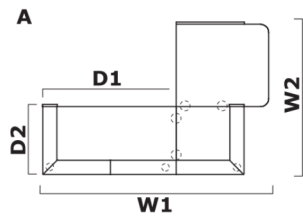
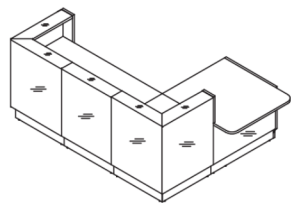

Symbol			Dimensions					kg m3 pcs	Composition elements
A	B		W1	W2	D1	D2	H		
LIN40L	LIN40P		2444	2050	1950	850	1105	332.5 kg 3.283 m3 16 pcs	A - B -

Extra charge					



Symbol			Dimensions					kg m3 pcs	Composition elements
A	B		W1	W2	D1	D2	H		
LIN41L	LIN41P		2744	1850	1622	850	1105	282.5 kg 2.674 m3 16 pcs	A - B -
LIN411L	LIN411P		2744	1650	1622	850	1105	277.5 kg 2.648 m3 16 pcs	A - B -

Extra charge						

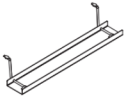
Composition elements							
	Symbol		Dimensions			kg m3 pcs	Comments
			Width	Depth	Height		
	NL41		585	142	712	2 kg 0.063 m3 1 pcs	
	S69L		580	162	123	1 kg 0.015 m3 1 pcs	
	E64L		460	89	120	0.5 kg 0.001 m3 1 pcs	

Extra charge						